

HELIUM SLA

FRAME PASSPORT

TYPE: 7E2
LAST UPDATE: 25/09/2017

#BeTOUGH

INDEX

0. UPDATES.....	3
1. GENERAL.....	3
1.1. Description	3
1.2. Part codes.....	3
2. MATERIAL	3
3. WEIGHT	3
3.1. Frame.....	3
3.2. Fork.....	3
4. GEOMETRY.....	4
5. CABLE ROUTING	4
5.1. Compatibility	4
5.2. Mechanical cable routing.....	4
6. PARTS	5
6.1. Fork.....	5
6.1.1. Material.....	5
6.1.2. Dimensions	5
6.1.3. Part codes	5
6.2. Headset.....	5
6.3. Seat post.....	6
6.4. Bottom bracket	6
6.5. Brakes.....	6
6.6. Derailleur	6
6.6.1. Front.....	6
6.6.2. Rear.....	6
7. WHEELS AND TIRES.....	7
7.1. Fork.....	7
7.2. Frame.....	7
7.3. Tires	7
8. WARRANTY INFORMATION.....	7
8.1. Maximum rider weight	7

0. UPDATES

The development of frames, forks and components is a continuous running process. Therefore we strongly advise before reading this information sheet check our website for new updates.

1. GENERAL

1.1. DESCRIPTION

Lighter is better right? Yes and no. Yes, it is better if it can transfer your power efficiently to the road. No, if all that effort you put into moving the bike forward simply goes up in flexing the frame back and forth. The Helium range is a non-compromising solution for the rider who demands the lightest weight from his bicycle yet still wants the bike to stay stiff and resilient under his feet. The Helium, and especially the SLX (which weighs less than 750 grams for size M), is still stiff enough to take all the stomping our sprinting ace, André Greipel, has to offer, yet light enough to float over the highest mountain passes with ease.

1.2. PART CODES

All the helium SLA frames have a particular part code composed by the letters "FRAHSARID...", added by 3 numbers. The three numbers change depending on the design and size of the frame. Due to the big amount of frames we don't list all the numbers but you can contact your local dealer for more information if needed.

2. MATERIAL

The Helium SLA is made of high quality 6061 tripple butted heat-treaded aluminum.

3. WEIGHT

3.1. FRAME

size	weight (*)
XXXS	1020 grams
XXS	1060 grams
XS	1100 grams
S	1140 grams
M	1180 grams
L	1220 grams
XL	1270 grams

(*) Weight of painted frame, real weight may differ from the weight mentioned above by 10 %.

3.2. FORK

The weight of the 4ZA Helium SLA fork is around 360 g (*).

(*) Weight of painted fork, real weight may differ from the weight mentioned above by 10 %.

4. GEOMETRY

SIZE	A	B	C	D	E	F	G	H	I	J*	S	R
XXXS	685	390	500	107	75.5	70.0	405	67	976	708	500	371
XXS	745	450	515	107	75.0	71.8	405	68	970	726	507	379
XS	775	480	525	127	74.0	72.0	405	68	970	751	527	374
S	805	510	545	142	73.5	73.0	405	66	977	774	573	384
M	835	540	565	172	73.0	73.5	405	66	987	804	573	390
L	865	570	585	202	72.5	73.5	405	63	1005	834	599	396
XL	895	600	600	227	72.5	74	408	63	1014	861	625	403

(*) J: Stand over height

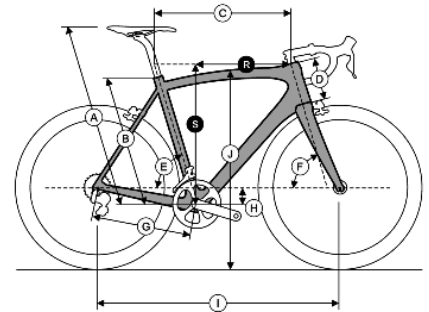

5. CABLE ROUTING

5.1. COMPATIBILITY

The Helium SLA is compatible for mechanical group sets only.

5.2. MECHANICAL CABLE ROUTING

Below you can see the cable routing parts of the Helium SLA.

PART	PART CODE	LOCATION
END CAP WITH LINER	CABSTIJAG037	HEAD TUBE RIGHT
END CAP WITH LINER	CABSTIJAG037	HEAD TUBE LEFT
RAIN AND DIRT PROTECTOR	CABSTIJAG038	SEAT TUBE
RAIN AND DIRT PROTECTOR	CABSTIJAG038	CHAINSTAY
END CAP WITH LINER	CABSTIJAG035	CHAINSTAY
RIDLEY BB CABLE GUIDE	CBGRCERID002	BOTTOM BRACKET

6. PARTS

6.1. FORK

The standard fork, used for a Helium SLA, is the 4ZA Helium SLA fork.

6.1.1. MATERIAL

Fork legs: Carbon
Steerer tube: Carbon

6.1.2. DIMENSIONS

Steerer tube length: 300 mm
Headset: 1 1/8" upper ring – 1 1/4" lower ring (1 1/8" - 1 1/2" in early 2017 models)
Fork rake: 45 mm
OLD (OverLock nut Distance): 100 mm

6.1.3. PART CODES

All the 4ZA Helium SLA forks have a particular part code composed by the letters "FORCFR4ZA...", added by 3 numbers. The three numbers, depending on the design. Due to the big amount of forks we don't list all the numbers but you can contact your local dealer for more information if needed.

6.2. HEADSET

45° Semi oversized angular contact bearing(S.H.I.S.: IS42/28,6|IS47/33):

Lower bearing: 1 1/4"
Upper bearing: 1 1/8"

Recommended headset:

RIDLEY PART CODE	TYPE	BRAND
HSERACFSA006	NO.44/CF	FSA

6.3. SEAT POST

The Helium SLA frame is developed to use a 27,2 mm seat post. To fix the seat post the 4ZA 31,8 mm (Part Code: SPCSNGNOB001) seat post clamp can be used.

6.4. BOTTOM BRACKET

The bottom bracket is BSA threaded and has a width of 68 mm to fit standard BSA68 cups.

6.5. BRAKES

The Helium SLA is suited for most standard brakes, available in the market.

6.6. DERAILLEUR

6.6.1. FRONT

The frame is designed to use a clamp on derailleur for a 31,8 mm seat tube. Also a braze on derailleur can be used if it's used together with the 4ZA 34,9 mm front derailleur clamp (Part code: FDCNOB4ZA004).

6.6.2. REAR

The hanger, used for the Helium SLA is the HANRCERID036.



7. WHEELS AND TIRES

7.1. FORK

The fork is developed for 700C race wheels with a build in width of 100 mm and a quick release system with a maximum diameter of 9 mm.

7.2. FRAME

The frame is developed for 700C race wheels with a build in width of 130 mm and a quick release system with a maximum diameter of 10 mm.

7.3. TIRES

We recommend a maximum tire width of 25 mm with a maximum rim width of 25 mm.

Please note that not all tire manufacturers use the same sizing standard so we recommend to do an assembly check and confirm clearances.

8. WARRANTY INFORMATION

8.1. MAXIMUM RIDER WEIGHT

The maximum advised rider weight is 110 kg.

#BeTOUGH