



# **NOAH FAST**

FRAME PASSPORT

TYPE: 7DC  
LAST UPDATE: 21/08/2015



**#BeTOUGH**

**INDEX**

<b>0. UPDATES.....</b>	<b>3</b>
<b>1. GENERAL.....</b>	<b>3</b>
1.1. Description .....	3
1.2. Part codes.....	3
<b>2. MATERIAL .....</b>	<b>3</b>
<b>3. WEIGHT .....</b>	<b>3</b>
3.1. Frame.....	3
3.2. Fork.....	3
<b>4. GEOMETRY.....</b>	<b>4</b>
<b>5. CABLE ROUTING .....</b>	<b>4</b>
5.1. Compatibility .....	4
5.2. Mechanical cable routing.....	4
5.3. Electronic cable routing .....	5
<b>6. PARTS .....</b>	<b>6</b>
6.1. Fork.....	6
6.1.1. Material.....	6
6.1.2. Dimensions .....	6
6.1.3. Part codes .....	6
6.2. Headset.....	7
6.3. Seat post.....	7
6.3.1. Cutting the seat post.....	7
6.3.2. Spacers .....	7
6.3.3. Saddle clamps .....	8
6.4. Bottom bracket .....	12
6.5. Brakes .....	12
6.5.1. Brake parts.....	13
6.6. Deraillieur .....	14
6.6.1. Front .....	14
6.6.2. Rear.....	14
6.7. Drop outs .....	14
<b>7. WHEELS AND TIRES.....</b>	<b>14</b>
7.1. Frame.....	14
7.2. Fork.....	15
7.3. Tires .....	15
<b>8. WARRANTY INFORMATION.....</b>	<b>15</b>
8.1 Maximum rider weight .....	15

## 0. UPDATES

The development of frames, forks and components is a continuous running process. Therefore we strongly advise before reading this information sheet check our website for new updates.

## 1. GENERAL

### 1.1. DESCRIPTION

The first bike with a “real” integrated brake, our F-Brake. The Noah FB incorporates all of our FAST-Concept technologies. These combined technologies offer up to 2.8km/h advantage in the sprint, and up to 20 watts less power input needed to average a 40km/h breakaway. The Noah FB is the ultimate frame in the World Tour peloton, no compromise, just pure speed.

### 1.2. PART CODES

All the Noah frames have a particular part code composed by the letters “FRANIBRID...”, added by 3 numbers. The three numbers change depending on the design and size of the frame. Due to the big amount of frames we don't list all the numbers but you can contact your local dealer for more information if needed.

## 2. MATERIAL

Used frame materials:

- 50 ton High Modulus Carbon
- 40 ton High Modulus Carbon
- 30 ton High Modulus Carbon
- Stainless steel (drop out protection plates)

## 3. WEIGHT

### 3.1. FRAME

SIZE	WEIGHT (*)
XS	1320 GRAMS
S	1360 GRAMS
M	1400 GRAMS
L	1450 GRAMS
XL	1500 GRAMS

(\*) Weight of painted frame, real weight may differ from the weight mentioned above by 10 %.

### 3.2. FORK

The weight of the 4ZA Fast Fork Race is around 510 g (\*)

(\*)Weight of painted fork, real weight may differ from the weight mentioned above by 10 %.

## 4. GEOMETRY

SIZE	A	B'	C	C'	D	E	F	G	H	I	J*	S	R
XS	440	670	510	525	130	74	72	405	68	974	740	530	375
S	470	700	530	545	145	73,5	73	405	66	977	750	545	385
M	500	740	550	560	175	73,5	73,5	405	66	990	780	575	390
L	530	770	570	585	205	72,5	73,5	408	63	1003	810	602	400
XL	560	800	585	600	230	72,5	74	408	63	1012	840	625	405

(\*): J: Standover height

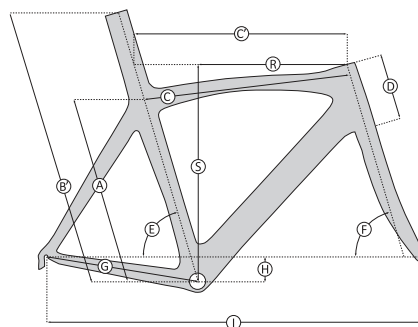

## 5. CABLE ROUTING

### 5.1. COMPATIBILITY

The Noah Fast is compatible for:

Mechanical groupsets

Electronical groupsets: Shimano Di2, Campagnolo EPS(\*) & SRAM eTap

(\*): The frame has to be specially prepared to be able to use Campagnolo EPS. Therefore it's needed to mention if the frame has to be compatible with Campagnolo EPS.

### 5.2. MECHANICAL CABLE ROUTING

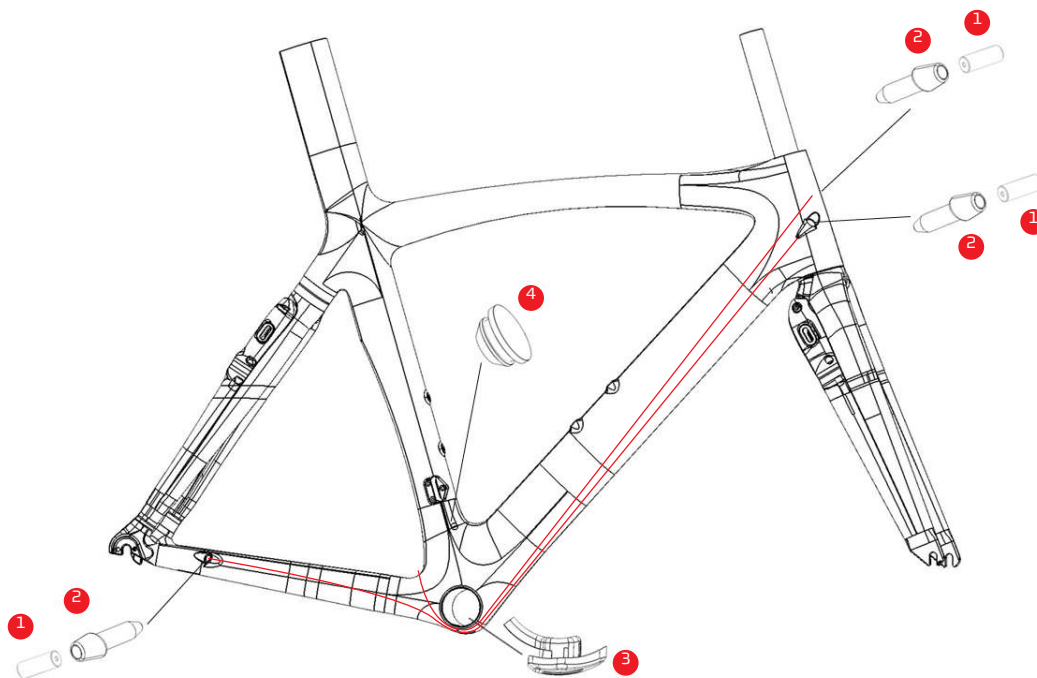

NO.	PART	PART CODE	QUANTITY
1	END CAP SHIFTER CABLE	CABSTIJAG037	3
2	CABLE STOPPER	FRPSTORID006	3
3	CABLE GUIDE	CBGRCERID009	1
4	CLOSED GROMMET	FRPGROJAG002	1

5.3. ELECTRONIC CABLE ROUTING

Below you can find a drawing of the parts needed for an electronic groupset:

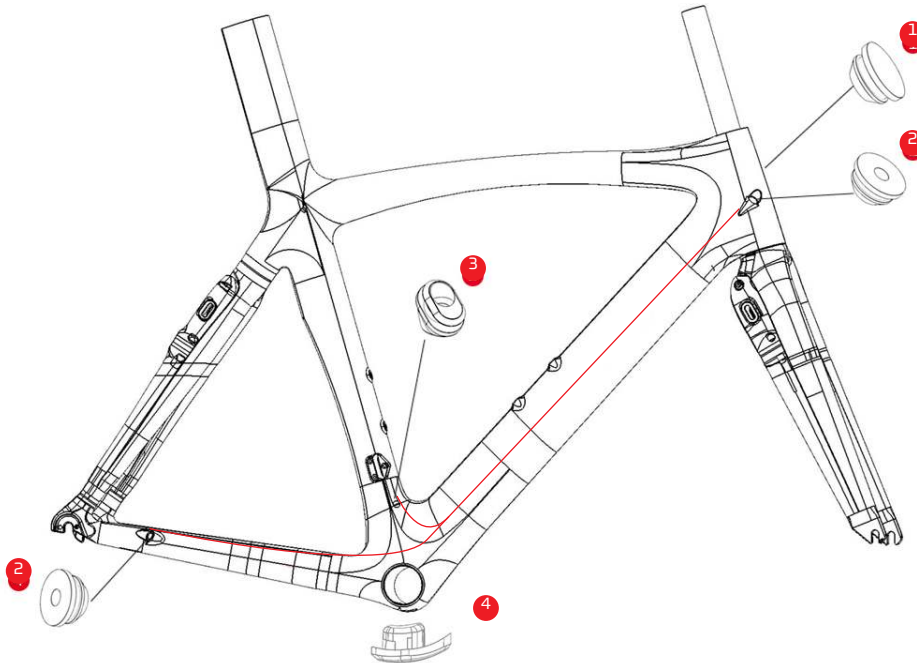

NO.	PART	PART CODE	QUANTITY
1	CLOSED GROMMET	FRPGROJAG002	1
2	OPEN GROMMET	FRPGROJAG003	2
3	DI2 GROMMET	FRPGROJAG009	1
4	BB GROMMET	FRPGRORID005	1

Battery mount position:

Shimano Di2: Under the saddle, mounted at the back of the saddle clamp.

Campagnolo EPS: On top of the down tube, below the bottle cage.

## 6. PARTS

### 6.1. FORK

The standard fork, used for a Noah Fast, is the 4ZA Fast fork race.

#### 6.1.1. MATERIAL

Fork legs: Carbon  
Steerer tube: Carbon

#### 6.1.2. DIMENSIONS

Steerer tube length: 300 mm  
Headset: 1 1/8" upper bearing – 1 1/2" lower bearing  
Fork rake: 44 mm  
OLD (OverLock nut Distance): 100 mm

#### 6.1.3. PART CODES

All the Noah Fast forks have a particular part code composed by the letters "FORIBSRID...", added by 3 numbers. The three numbers, depending on the design and size of the fork. Due to the big amount of forks we don't list all the numbers but you can contact your local dealer for more information if needed.

## 6.2. HEADSET

45° Oversized angular contact bearing (S.H.I.S. : IS42/28.6| IS52/40):

Lower bearing: 1 1/2"

Upper bearing: 1 1/8"

Recommended headset:

RIDLEY PART CODE	TYPE	BRAND
HSERACFSA004	NO.42/ACB	FSA
HSERACFSA005	NO.42/CFST/ACB	FSA

## 6.3. SEAT POST

### 6.3.1. CUTTING THE SEAT POST

Cut the integrated seat post at a desired length with the help of a standard metal saw and the Ridley cutting guide (Part code: SPCDEA4ZA007). Use a Ridley aero saddle clamp to fit the saddle on the integrated seat post.

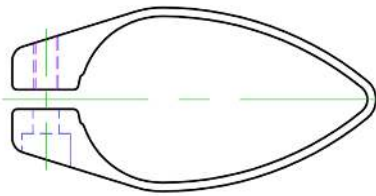

**! KEEP IN MIND THE MAXIMUM CUT OFF LENGTH OF 70 MM.**

### 6.3.2. SPACERS

The bottom of the saddle clamp has to be supported. If the saddle clamp doesn't touch the top of the seat tube it's necessary to fill up the gap between seat tube and saddle clamp with spacers. Below you can find a list with all the available spacers.

PART CODE	DESCRIPTION	THICKNESS
SPCDEA4ZA002	ALLOY SPACER	10 MM
SPCDEA4ZA003	ALLOY SPACER	1 MM
SPCDEA4ZA004	ALLOY SPACER	3 MM
SPCDEA4ZA005	ALLOY SPACER	5 MM
SPCDEA4ZA006	ALLOY SPACER	8 MM

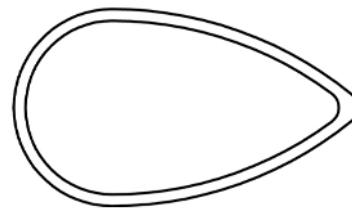

**! KEEP IN MIND THAT THERE IS A THE MAXIMUM AMOUNT OF SPACERS. THE MINIMUM INSERT LINE ON THE SADDLE CLAMP HAS TO BE BELOW THE TOP OF THE SEAT TUBE.**

**6.3.3. SADDLE CLAMPS**

Dependent on the position of the rider and the purpose the bike will be used for there are different saddle clamps listed below.

PART CODE	DESCRIPTION
SPCDEA4ZA008	SADDLE CLAMP RACE, BLACK
SPCDEA4ZA010	SADDLE CLAMP TT/TRI, BLACK
SPCDEA4ZA011	SADDLE CLAMP TT/TRI, BLACK, EXTRA HIGH
SPCDEA4ZA012	SADDLE CLAMP RACE, BLACK, EXTRA HIGH
SPCDEA4ZA013	SADDLE CLAMP RACE, WHITE
SPCDEA4ZA014	SADDLE CLAMP TT/TRI, WHITE
SPCDEA4ZA015	SADDLE CLAMP RACE, BLACK, DI2
SPCDEA4ZA016	SADDLE CLAMP RACE, WHITE, EXTRA HIGH
SPCDEA4ZA017	SADDLE CLAMP RACE, BLACK, DI2, TWO BOLT SYSTEM
SPCDEA4ZA018	SADDLE CLAMP RACE, WHITE, DI2

**SPCDEA4ZA008 (Black) & SPCDEA4ZA013 (White): Saddle Clamp Race**

AVAILABLE COLOR OPTIONS	BLACK & WHITE
NUMBER OF SEAT ANGLE POSITIONS	3
MAXIMUM SPACER HEIGHT <sup>(1)</sup>	20 MM
DI2 HOLE <sup>(2)</sup>	NO

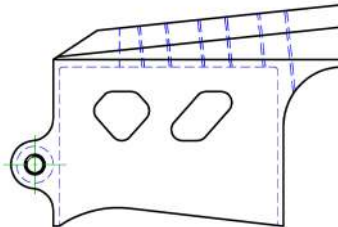
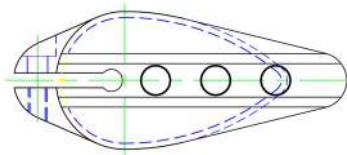

RACE			
SIZE	E (SEAT TUBE ANGLE)	1 (FRONT)	2 (REAR)
XS	74	72,5	71,5
S	73,5	72	71
M	73	71,5	70,5
L	72,5	71	70
XL	72,5	71	70

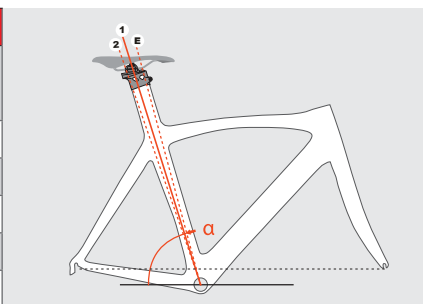



*SPCDEA4ZA010 (Black) & SPCDEA4ZA014 (White): Saddle Clamp TT/TRI*

AVAILABLE COLOR OPTIONS	BLACK & WHITE
NUMBER OF SEAT ANGLE POSITIONS	2
MAXIMUM SPACER HEIGHT <sup>(1)</sup>	20 MM
DI2 HOLE <sup>(2)</sup>	NO

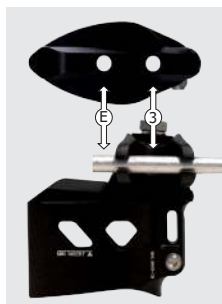
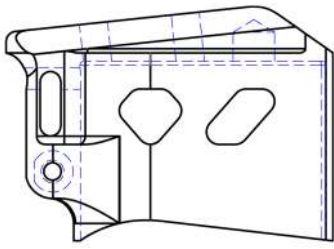
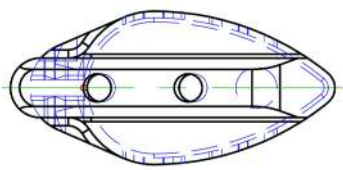

TT		
SIZE	E (SEAT TUBE ANGLE)	3 (FRONT)
XS	74	76
S	73,5	75,5
M	73	75
L	72,5	74,5
XL	72,5	74,5

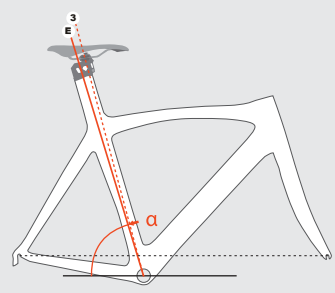

*SPCDEA4ZA011: Saddle Clamp TT/TRI, Extra High*

AVAILABLE COLOR OPTIONS	BLACK
NUMBER OF SEAT ANGLE POSITIONS	2
MAXIMUM SPACER HEIGHT <sup>(1)</sup>	40 MM
DI2 HOLE <sup>(2)</sup>	NO

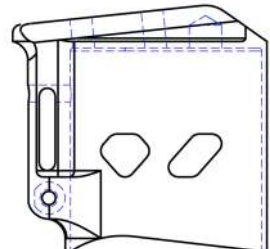
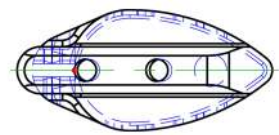

TT		
SIZE	E (SEAT TUBE ANGLE)	3 (FRONT)
XS	74	76
S	73,5	75,5
M	73	75
L	72,5	74,5
XL	72,5	74,5

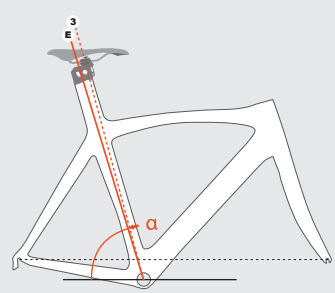

*SPCDEA4ZA012 (Black) & SPCDEA4ZA016 (White): Saddle Clamp Race, ExtraHigh*

AVAILABLE COLOR OPTIONS	BLACK & WHITE
NUMBER OF SEAT ANGLE POSITIONS	3
MAXIMUM SPACER HEIGHT <sup>(1)</sup>	40 MM
DI2 HOLE <sup>(2)</sup>	NO

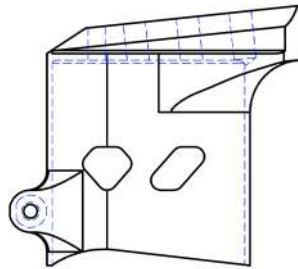
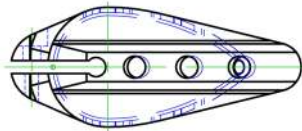

RACE			
SIZE	E (SEAT TUBE ANGLE)	1 (FRONT)	2 (REAR)
XS	74	72,5	71,5
S	73,5	72	71
M	73	71,5	70,5
L	72,5	71	70
XL	72,5	71	70

*SPCDEA4ZA015 (Black) & SPCDEA4ZA018 (White): Saddle Clamp Race, Di2*

AVAILABLE COLOR OPTIONS	BLACK & WHITE
NUMBER OF SEAT ANGLE POSITIONS	3
MAXIMUM SPACER HEIGHT <sup>(1)</sup>	20 MM
DI2 HOLE <sup>(2)</sup>	YES

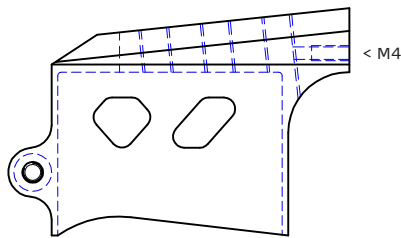
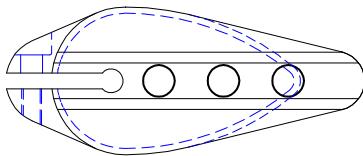

RACE			
SIZE	E (SEAT TUBE ANGLE)	1 (FRONT)	2 (REAR)
XS	74	72,5	71,5
S	73,5	72	71
M	73	71,5	70,5
L	72,5	71	70
XL	72,5	71	70

*SPCDEA4ZA017: Saddle Clamp Race, Di2, Two Bolt System*

AVAILABLE COLOR OPTIONS	BLACK & WHITE
NUMBER OF SEAT ANGLE POSITIONS	1
MAXIMUM SPACER HEIGHT <sup>(1)</sup>	20 MM
DI2 HOLE <sup>(2)</sup>	YES

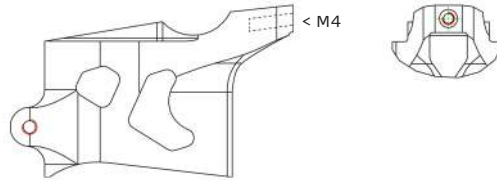
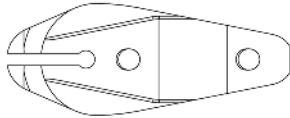

TT		E (SEAT TUBE ANGLE)
SIZE		
XS		74
S		73,5
M		73
L		72,5
XL		72,5

- (1) The maximum allowed spacers height between the integrated seat post and the saddle clamp. This is just a reference value, never use more spacers than mentioned by the mark on the saddle clamp.
- (2) The Di2 hole is a threaded hole (M4) to be able to mount a Shimano Di2 battery (short mount) at the back of the saddle clamp.  
The hole can also be used for other purposes (e.g. to mount a number plate).

**6.4. BOTTOM BRACKET**

The bottom bracket is designed for press fit 30 cups with a diameter of 46 mm and width of 68 mm.

Below bottom bracket cups are being used for the standard assembled bikes.

PART CODE	BRAND	DESCRIPTION	COMPATIBLE CRANKSETS
BBRPF3SRA001	SRAM	PRESS FIT 30 CUPS	SRAM PRESS FIT 30 CRANKSETS
BBRPF3SRA003	SRAM	PRESS FIT 30 TO BSA 68 ADAPTER	SRAM BSA 68 CRANKSETS SHIMANO BSA 68 CRANKSETS
BBRPF3CAM002	CAMPAGNOLO	ULTRA TORQUE™ OS-FIT™ INTEGRATED CUPS BB30 68X46	CAMPAGNOLO ULTRA TORQUE CRANKSETS
BBRPF3CAM003	CAMPAGNOLO	POWER TORQUE™ OS-FIT™ INTEGRATED CUPS BB30 68X46	CAMPAGNOLO POWER TORQUE CRANKSETS
BBRPF3CBE005	C-BEAR	C-BEAR CUPS FOR SHIMANO, FSA AND ROTOR 24 MM AXLES	SHIMANO HOLLOWTECH II, FSA MEGA EXO, ROTOR 3D

**6.5. BRAKES**

The special F-Brakes® are integrated in frame and fork. In the next section you can find an overview of all the brake parts.

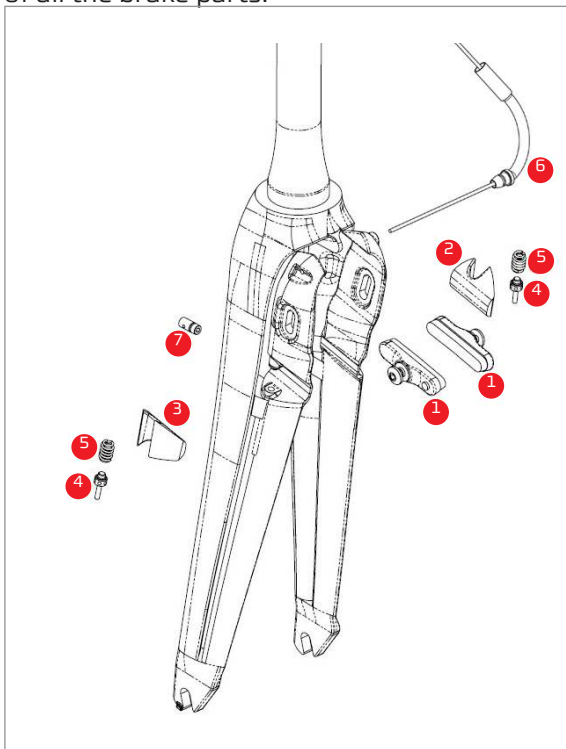

NO.	PART	PART CODE	QUANTITY
1	BRAKE PAD SET	BRPSPRJAG001	1
2	RIGHT FOAM, FORK	FOPFOA4ZA002	1
3	LEFT FOAM, FORK	FOPFOA4ZA001	1
4	ADJUSTER SCREW	BRPIBS4ZA001	2
5	SPRING	BRPIBS4ZA006	2
6	CABLE GUIDE	CABBRAJAG032	1
7	CABLE CLAMP	BRPIBS4ZA002	1

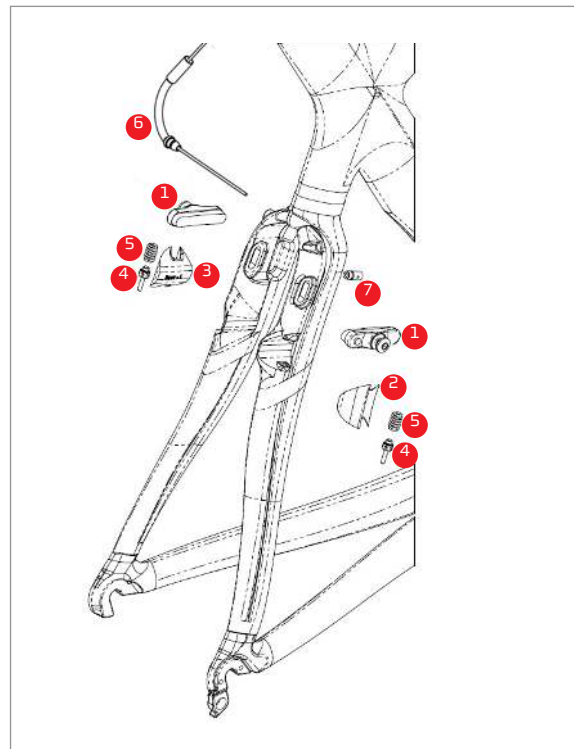

NO.	PART	PART CODE	QUANTITY
1	BRAKE PAD SET	BRPSPRJAG001	1
2	RIGHT FOAM, FRAME	FRPFOA4ZA002	1
3	LEFT FOAM, FRAME	FRPFOA4ZA001	1
4	ADJUSTER SCREW	BRPIBS4ZA001	2
5	SPRING	BRPIBS4ZA006	2
6	CABLE GUIDE	CABBRAJAG032	1
7	CABLE CLAMP	BRPIBS4ZA002	1

### 6.5.1. BRAKE PARTS

#### Brake pads

You will be able to use most available brake pads however we recommend the brake pads mentioned below.

Recommended brake pads:

#### For alloy rims

Brand: Jagwire

Type: Sleek Pro Road brake pad

Ridley part code: BRPSPRJAG001

#### For carbon rims

For carbon rims you can use the same pad holders as mentioned above for alloy rims but you have to replace the brake pads. We recommend BRPRAC4ZA004 brake pads for carbon rims.

#### Foam

To fill the gap in the flexible area of the brakes, a special foam is used. For each position there's a different foam part like illustrated in the drawing.

#### Adjuster screws

Adjusting the alignment of the brakes is done by adjuster screws to adjust the tension of the springs in the flexible areas. In the standard position the screws are completely screwed into the frame or fork. You can achieve the right setup in the way explained below.

- Brakes are perfect aligned in the standard position  
You don't have to adjust anything.
- Brakes are not perfect aligned in the standard position  
If the clearance between the brake pads and the rim is not the same for both sides, unscrew the screw on the side where the clearance is the most. Unscrewing the screw will increase the tension on the spring causing the brake arm to move in the direction of the rim.

**! BEFORE ADJUSTING THE BRAKE ALIGNMENT WITH THE ADJUSTER SCREWS CHECK THE WHEEL ALIGNMENT TO BE SURE THE WHEEL IS PERFECTLY ALIGNED.**

**! DO NOT UNSCREW THE ADJUSTER SCREWS MORE THAN 3 MM.**

**! DO NOT OVERTIGHTEN THE BRAKE NUT BOLTS WHILE FIXING THE BRAKEPADS IN THE BRAKE ARM. THE MAXIMUM ALLOWED TORQUE IS 5NM**

### Springs

Together with the adjuster screws the springs make it able to adjust the tension on the brake arms and align the brake arms in a perfect position.

### Cable guide

Cable guide to guide the brake cable from the brake to the frame.

### Cable clamp

The cable clamp is needed to fix the brake cable.

## 6.6. DERAILLEUR

### 6.6.1. FRONT

The frame is provided with a braze on mount.

### 6.6.2. REAR

The hanger, used for the Noah Fast is the HAARCERID026.



## 6.7. DROP OUTS

The carbon drop outs have stainless steel inserts for extra protection.

# 7. WHEELS AND TIRES

### 7.1. FRAME

The frame is developed for 700C race wheels with a build in width of 130 mm and a quick release system with a maximum diameter of 10 mm.

**Brake - wheel clearance**

The F-Brake can accommodate wheels with a maximum brake surface width of 23 mm.

**Frame - wheel clearance**

The frame can accommodate wheels with a maximum rim width of 30 mm.

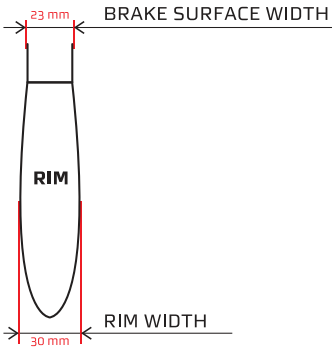
**7.2. FORK**

The fork is developed for 700C race wheels with a build in width of 100 mm and a quick release system with a maximum diameter of 9 mm.

**Brake - wheel clearance**

The F-Brake can accommodate wheels with a maximum brake surface width of 23 mm.

**Fork - wheel clearance**

The fork can accommodate wheels with a maximum rim width of 30 mm.

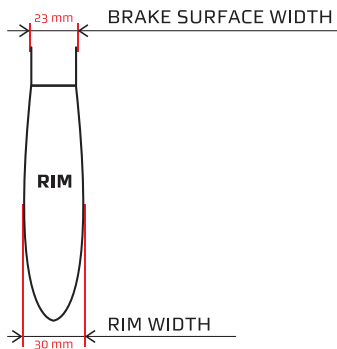
**7.3. TIRES**

The maximum recommended tire width is 25 mm.

Please note that not all tire manufacturers use the same sizing standard so we recommend to do assembly check and confirm clearances.

**8. WARRANTY INFORMATION****8.1 MAXIMUM RIDER WEIGHT**

The maximum advised rider weight is 95 kg.

**#BeTOUGH**